

序号/Rev No	名称/Title	材料/Material	文件编号/File No
1	端子/Pin Header	Brass, Sn Plated	
2	螺母/Nut	CPCC	

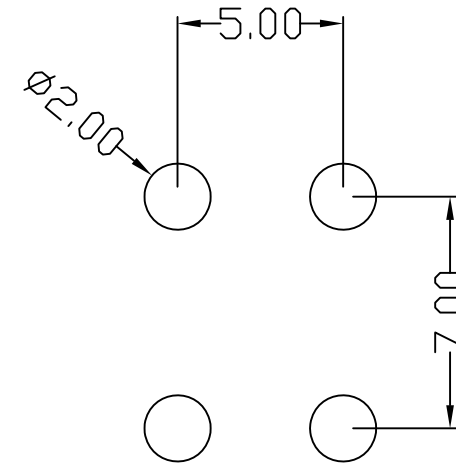

PCB LAYOUT

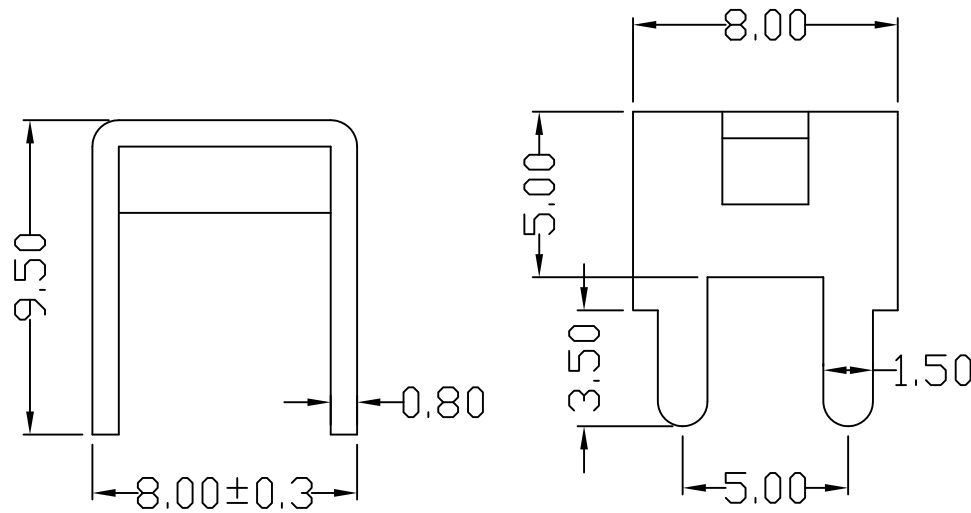
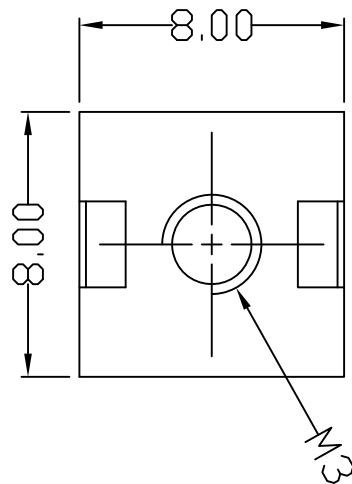

注/Note

额定电流/Rated Current (A) : 35
 额定扭矩/Rated torque (N·m) : 0.8
 螺孔/Screw hole: M3

未注公差/Undeclared tolerance															
Plastic parts Dimension(mm)	0 ~ 1	1 ~ 3	3 ~ 6	6 ~ 10	10 ~ 15	15 ~ 22	22 ~ 30	30 ~ 40	40 ~ 53	53 ~ 70	70 ~ 90	90 ~ 120	120 ~ 160	160 ~ 200	200 ~ 250
Solder needle length Dimension(mm)	1 ~ 6	6 ~ 10	10 ~ 15												
	±0.10	±0.11	±0.12	±0.14	±0.17	±0.20	±0.24	±0.28	±0.33	±0.40	±0.50	±0.60	±0.75	±0.95	±1.15
	±0.3	±0.35	±0.45												

设计/Designed by	绘图/Drawing by	审核/Checked by	批准/Approved by
		图名/Title	文件编号/File No.
		XYMV41030	QJ/XYT-M100800
版本/VER 00 备注/Remark		单位/Units:	mm

序号/RevNo.	更改记录/Revision note	签名/Signature	日期/Date