

序号/Rev No	名称/Title	材料//Material	文件编号/File No
1	XY2500FL-Housing	PA66 (UL94V-0)	
2	XY2500FL-Pin1	Brass (Sn Plated)	
3	XY2500FL-Pin2	Brass (Sn Plated)	

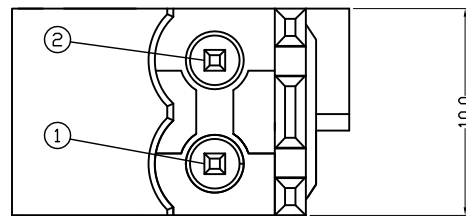
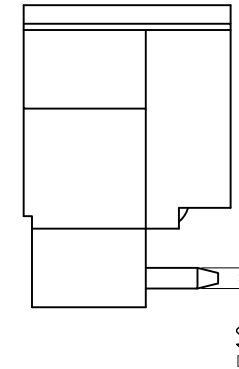
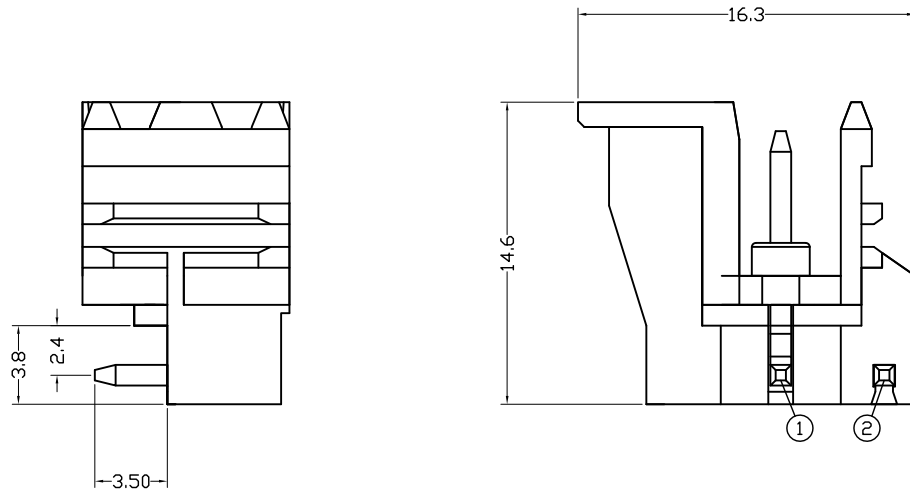

Note

Poles: P=2P

Pitch: 5.0mm

Use and Performance

Rated voltage:300V

Rated current:15A

Withstanding voltage:AC2500V/Min

Ambient temperature:-40℃~+105℃

未注公差/Undeclared tolerance

	0	1	3	6	10	15	22	30	40	53	70	90	120	160	200
Plastic parts Dimension(mm)	±0.10	±0.11	±0.12	±0.14	±0.17	±0.20	±0.24	±0.28	±0.33	±0.40	±0.50	±0.60	±0.75	±0.95	±1.15
Solder needle length Dimension(mm)	3.5														
	±0.5														

设计/Designed by	绘图/Drawing by	审核/Checked by	批准/Approved by
图名/Title		文件编号/File No.	
XY2500RF-2P		版本/VER	00
备注/Remark		单位/Units:	mm

XINLAIYA 新莱亚电子
XINLAIYA ELECTRONIC CO., LTD

序号/RevNo.	更改记录/Revision note	签名/Signature	日期/Date

序号/Rev No	名称/Title	材料/Material	文件编号/File No
1	XY2500FL-Housing	PA66 (UL94V-0)	
2	XY2500FL-Pin1	Brass (Sn Plated)	
3	XY2500FL-Pin2	Brass (Sn Plated)	
4	XY2500FL-Pin3	Brass (Sn Plated)	

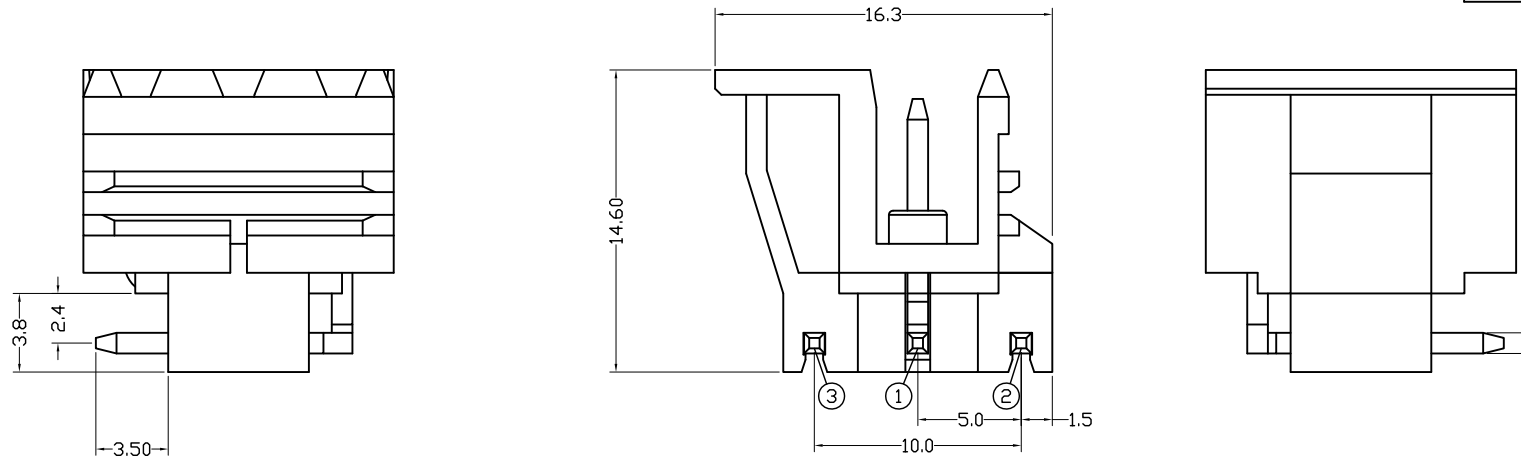

Note

Poles: P=3P

Pitch: 5.0mm

Use and Performance

Rated voltage:300V

Rated current:15A

Withstanding voltage:AC2500V/Min

Ambient temperature:-40℃~+105℃

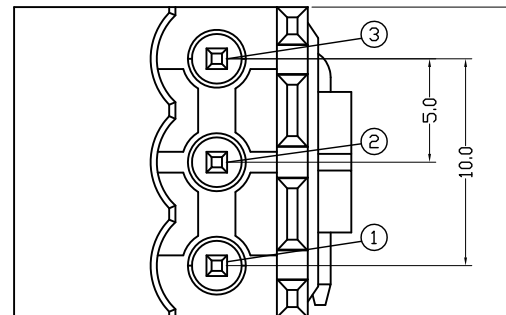

未注公差/Undeclared tolerance															
Plastic parts Dimension(mm)	0 1	1 3	3 6	6 10	10 15	15 22	22 30	30 40	40 53	53 70	70 90	90 120	120 160	160 200	200 250
Solder needle length Dimension(mm)	±0.10	±0.11	±0.12	±0.14	±0.17	±0.20	±0.24	±0.28	±0.33	±0.40	±0.50	±0.60	±0.75	±0.95	±1.15
	±0.5														

设计/Designed by	绘图/Drawing by	审核/Checked by	批准/Approved by
		图名/Title	文件编号/File No.
		XY2500RF-3P	
		备注/Remark	版本/VER 00
			单位/Units: mm

序号/RevNo.	更改记录/Revision note	签名/Signature	日期/Date

序号/Rev No	名称/Title	材料/Material	文件编号/File No
1	XY2500LF-Housing	PA66 (UL94V-0)	
2	XY2500LF-Pin1	Brass (Sn Plated)	
3	XY2500LF-Pin2	Brass (Sn Plated)	
4	XY2500LF-Pin3	Brass (Sn Plated)	
5	XY2500LR-Pin4	Brass (Sn Plated)	

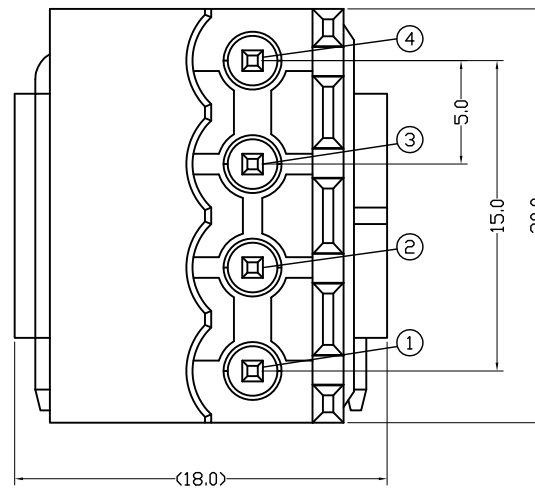
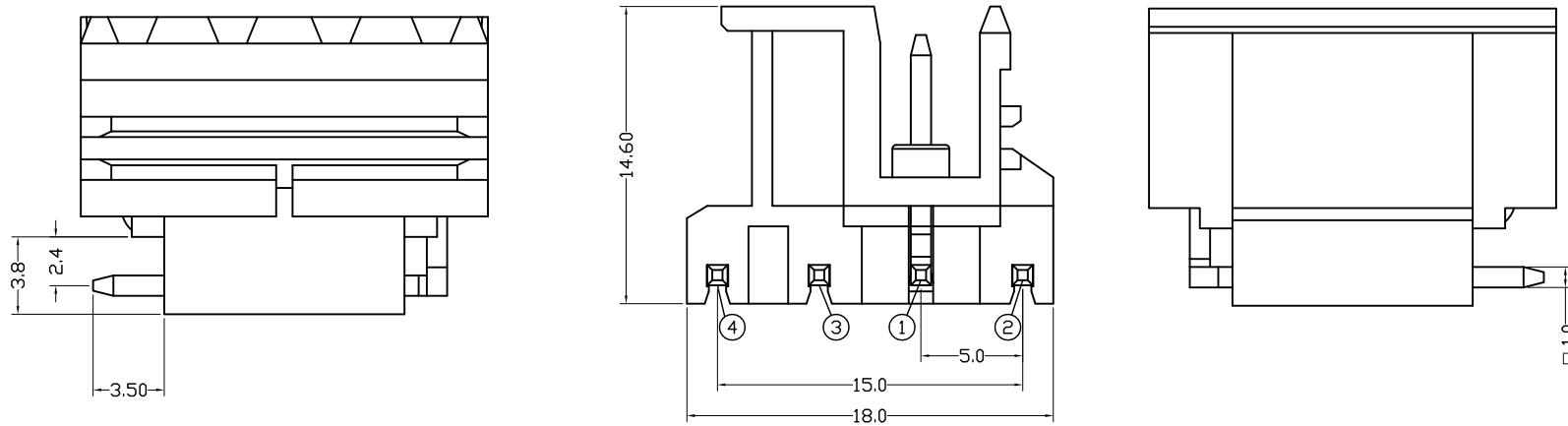

Note
Poles: P=4P
Pitch: 5.0mm

Use and Performance
Rated voltage:300V
Rated current:15A
Withstanding voltage:AC2500V/Min
Ambient temperature:-40℃~+105℃

未注公差/Undeclared tolerance															
Plastic parts Dimension(mm)	0 ~ 1	1 ~ 3	3 ~ 6	6 ~ 10	10 ~ 15	15 ~ 22	22 ~ 30	30 ~ 40	40 ~ 53	53 ~ 70	70 ~ 90	90 ~ 120	120 ~ 160	160 ~ 200	200 ~ 250
Solder needle length Dimension(mm)	±0.10	±0.11	±0.12	±0.14	±0.17	±0.20	±0.24	±0.28	±0.33	±0.40	±0.50	±0.60	±0.75	±0.95	±1.15
	±0.5														

设计/Designed by	绘图/Drawing by	审核/Checked by	批准/Approved by
		图名/Title	文件编号/File No.
		XY2500RF-4P	
		备注/Remark	版本/VER: 00
			单位/Units: mm

序号/RevNo.	更改记录/Revision note	签名/Signature	日期/Date